



TPGAA – PRESSURE TRANSMITTER

PRESSURE TRANSMITTERS FOR OEM CUSTOMERS

TPGAA series pressure transmitter is a mass production, cost effective for OEM, high quality and high reliability product applied to both civil and industrial.

Widely used to measure on-site pressure of compressor, auto and air-condition, etc., this product adopts 316L stainless steel structure, piezoresistive sensor chip imported from Germany.

Calibration and compensation are done with digital technique.

Standard current and voltage output.

The mass production adopts military technique, to optimize the manufacturing process.

CE certification.

Features:

- Accuracy: 1%FS ($\pm 0.5\%$ FS);
- High stability, high reliability;
- Piezoresistive core from Germany;
- Digital calibration;
- Multiple pressures;
- CE certification;
- Conform with RoHs standard.

APPLICATIONS

- COMPRESSOR
- BUILDING WATER SUPPLY
- HYDRAULIC CONTROL
- AIR-CONDITIONING UNIT
- AUTO ENGINE
- AUTOMATIC DETECTION SYSTEM
- HYDRAULIC UNIT
- REFRIGERATION EQUIPMENT

Ascon Tecnolog s.r.l.
viale Indipendenza, 56 - 27029 Vigevano (PV) Italy
tel +39 0381 69 871 - fax +39 0381 69 87 30
info@ascontecnologic.com
www.ascontecnologic.com

COMPANY WITH
MANAGEMENT SYSTEM
CERTIFIED BY DNV GL
= ISO 9001 =
= OHSAS 18001 =

SPECIFICATIONS (@ 20°C)

Model	TPGAA	
Pressure Range	-1/0 bar, 2... 600 bar	
Overload pressure	1.5 times rated output	
Failure pressure	3 times rated output	
Accuracy	1% FS ($\pm 0.5\%$ FS)	
Stability	Typical value: 0.5% FS, Max. value: 1% FS	
Operating Temperature	-40... +135°C	
Compensation Temperature	-10... +85°C	
Storage Temperature	-50... +135°C	
Medium compatibility	All corrosive medium compatible with AISI 316L	
Electrical feature	2-wires	3-wires
Signal output	4/20 mA	0.5... 4.5 V
Power supply	10/30 or 8/36 Vdc	5 Vdc
Load resistance	(U-10)/0.02 Ω	>100 k Ω
Insulation	>100 M Ω @ 50 V	
Electrical connection	Packard, DIN43650C; DIN72585; M12 series; Cable DIN43650A	
Shell and Lead protection	IP67	
Body and Membrane material	AISI 316L	
Pressure connection	G1/4; NPT1/4; 7/16-20UNF; R1/4	
Response time	10 ms	
Pressure form	Gauge pressure: G; Absolute Pressure: A	
Certification	RoHs Certification, CE Certification	
Electromagnetic compatibility	Electromagnetic radiation: EN50081-1/2, Electromagnetic sensitivity: EN50082-2	

DIMENSIONS [mm]

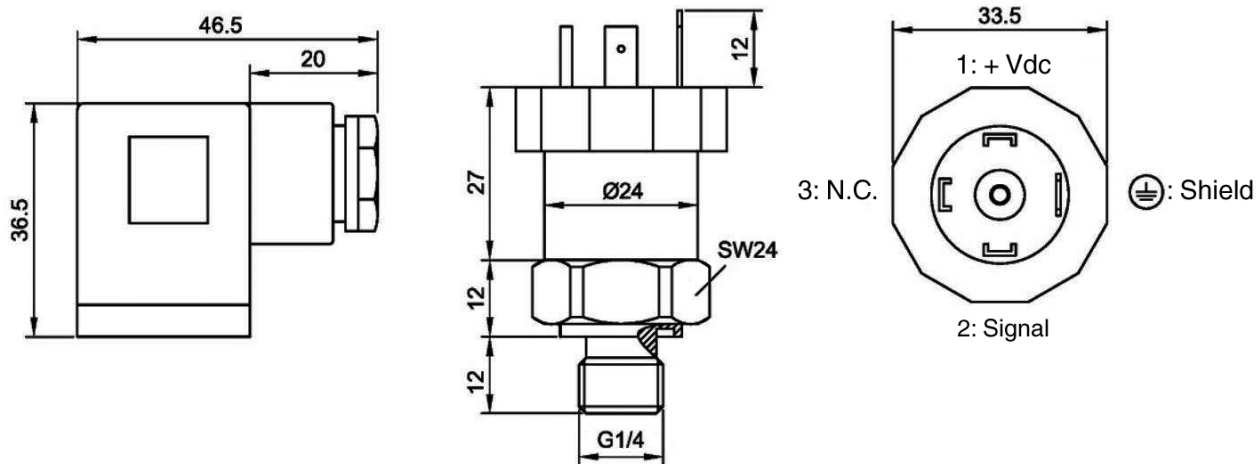

Ascon Tecnologic France
 BP 76 · 77202 - Marne La Vallée Cedex 1
 tel +33 1 64 30 62 62 · fax +33 1 64 30 84 98
 info@ascontecnologic.fr
 www.ascontecnologic.fr

Ascon Polska Sp. z o.o.
 KOCHCICE ul. Kochanowicka 43
 42-713 Kochanowice
 tel +48 34 35 33 619 · fax +48 34 35 33 884
 info@ascon.pl
 www.ascon.pl

Ascon Tecnologic - North America
 111 Brook Park Road
 Cleveland, OH 44109
 tel. +1 216 485 8350 ext. 229
 info@ascontec-na.com
 www.ascontecnologic.com/en

Coelmatic Ltda
 Rua Clélia 1810 - Lapa
 Sao Paulo · SP - CEP 05042-001- Brazil
 tel. +55 11 2066-3211 · fax +55 11 3046-8601
 info@coel.com.br
 www.coelmatic.com.br

Coelmatic SAPI SA de CV
 Dr. Pedro Noriega #1099 - Col Terminal
 Monterrey, Nuevo León - CEP 64570
 tel. +52 81 8104 1012
 info@coelmatic.com.mx
 www.coelmatic.com.mx



Distributors and assistance Worldwide. Contact Ascon Tecnologic for more info.